

SPINTSO REFEREE WATCH2 X MANUAL

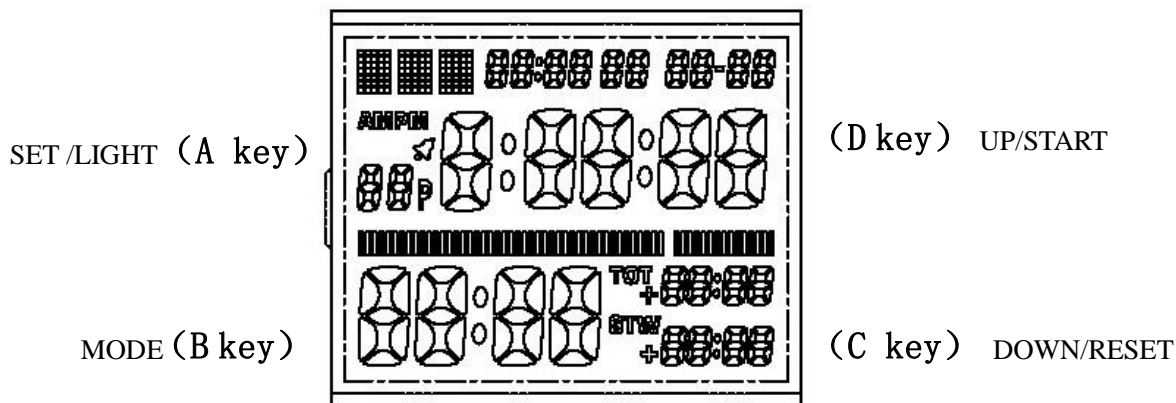

(Article number SPT140)



A. Features

- Display hour, minute, second, year, month, date, week
- Auto Calendar: 2000 ~ 2099 year
- 12/24 hour format
- World time: 24 time zones, 50 cities
- Stopwatch with 99 LAP memory
- Interval training mode: 1-99 period
- Referee mode
- Alarm
- EL backlight
- Keytone (B sound once push the button)

B. Mode

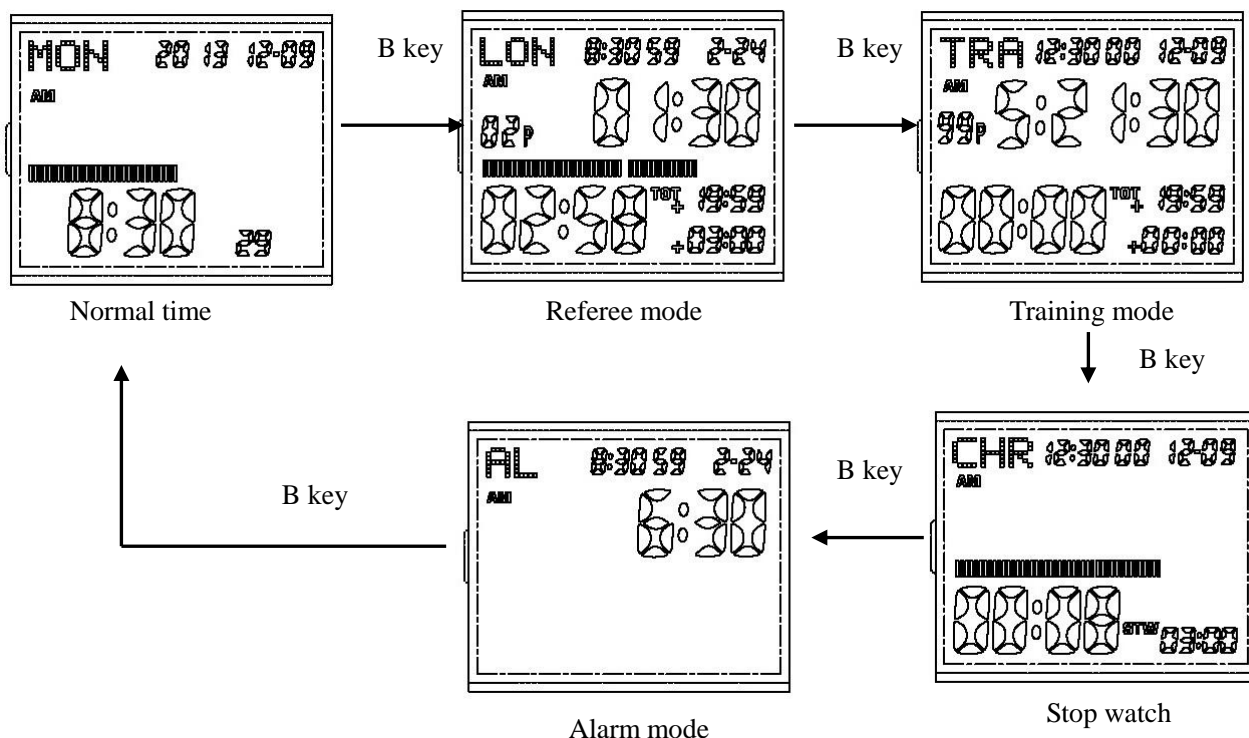

- Anytime, press A key EL Backlight for 3 seconds
- Normal time mode, press B key to choose operation mode

SPINTSO REFEREE WATCH2 X MANUAL



(Article number SPT140)

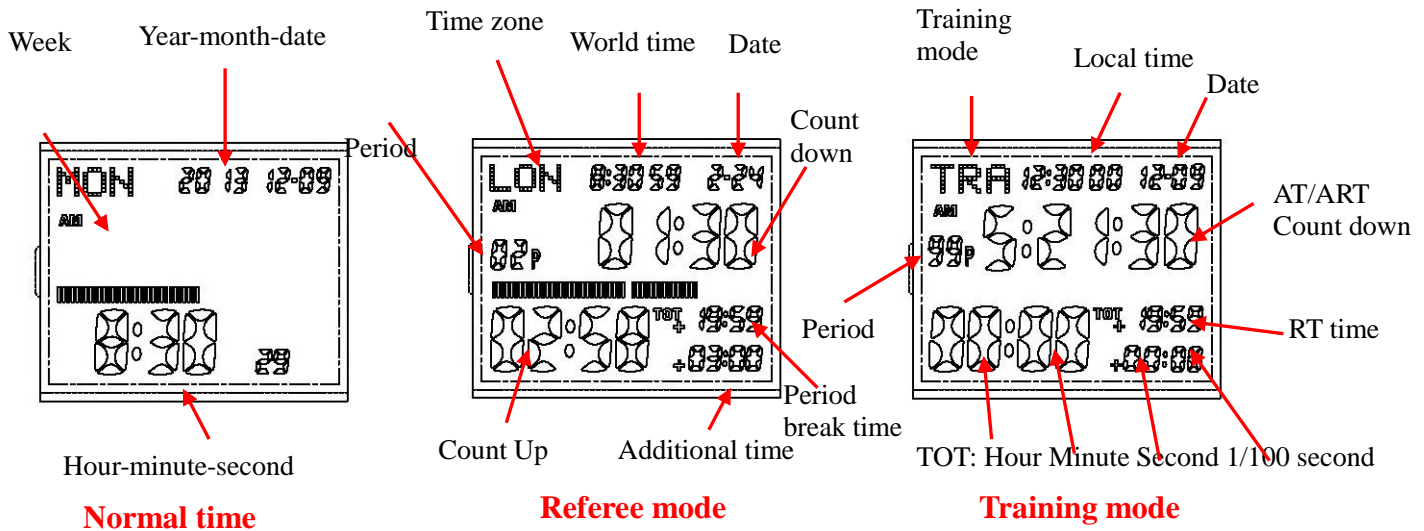

1. Time and date setting

➤ When in normal time mode, press A key 3 seconds to enter setting, press B key will flash as below sequence:

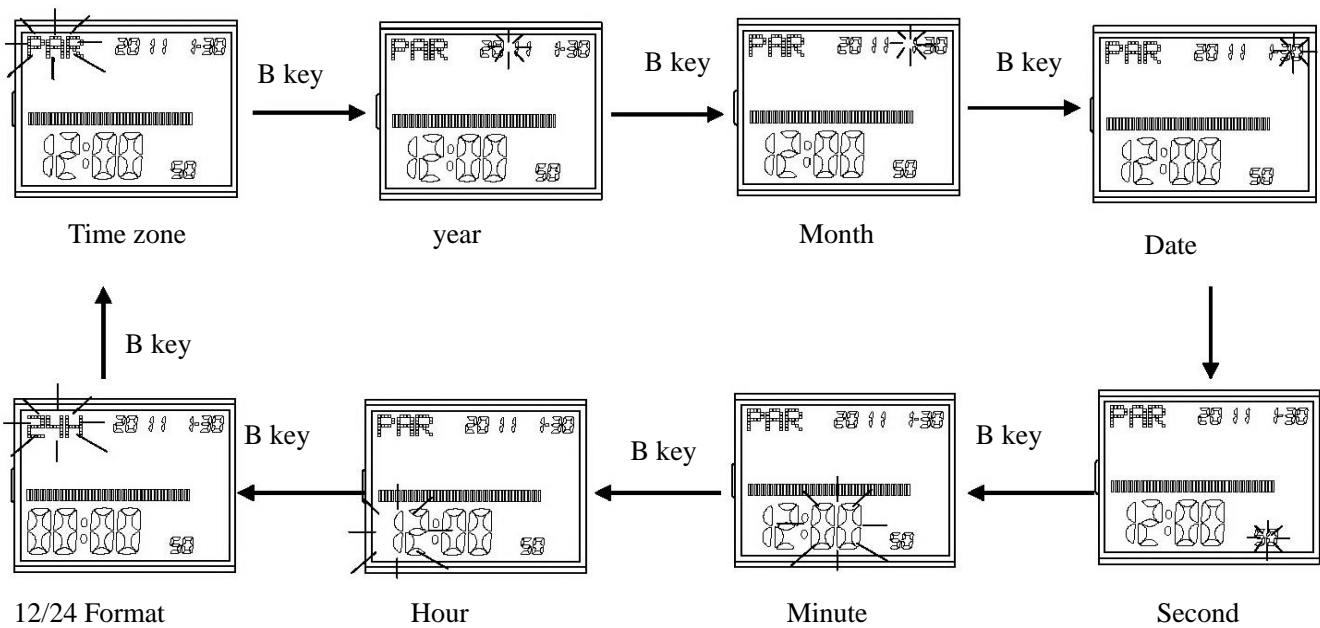

- Press D to adjust up the time zone or increase the values, keep press D key to soon adjust up time zone or fast increase the values
- Press C to adjust down the time zone or decrease the values, keep press C key to soon adjust down time zone or fast decrease the values.
- When adjust the second, press D or C to clear seconds to 00
- It will return to interval training mode automatically after 1 minute if there's no key pressed

2. Referee mode

Timing range

- The display range of countdown is: 01~99 minutes.
- The display range of count up is: 01~ 99 minutes 59 seconds
- The display range of period break time is: 01~ 99 minutes
- The display range of additional time is: 99 minutes 59 second.
- The watch will automatically stop after counting down of final period is finished, keep press C key for 3 seconds to clear the game data, but the original setting will not be cleared.

SPINTSO REFEREE WATCH2 X MANUAL



(Article number SPT140)

Referee countdown setting:

- When in referee mode, press A key 3 seconds to enter setting, press B key will flash as below sequence

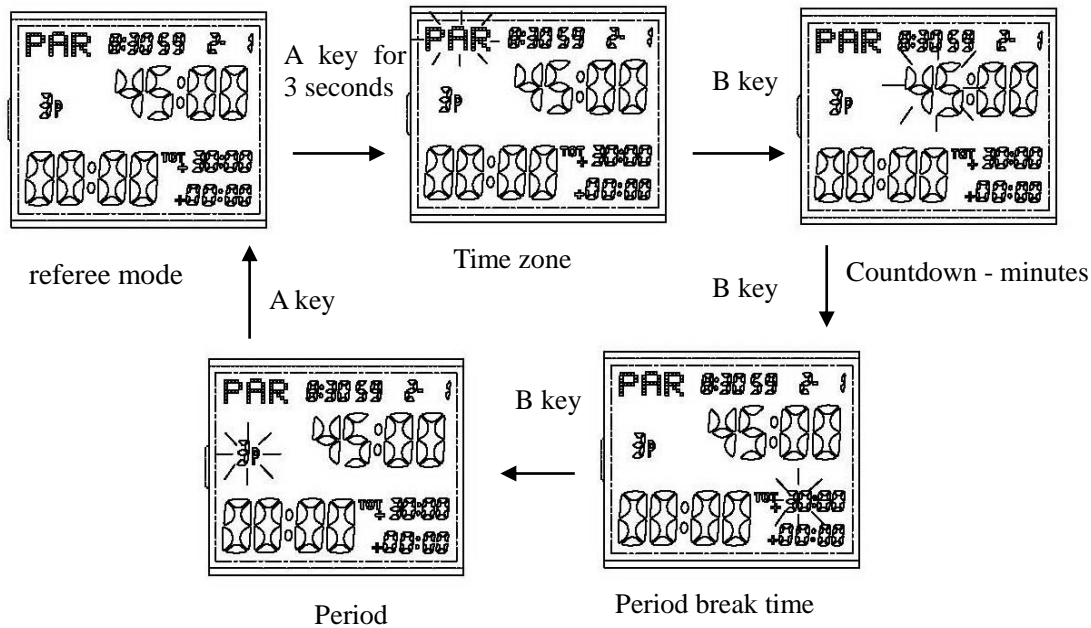

- Press D to adjust the time zone or increase the values, keep press D key to soon adjust up time zone or fast increase the values
- Press C to adjust down the time zone or decrease the values, keep press C key to soon adjust down time zone or fast decrease the values.
- Press A key to confirm and exit the setting, return to referee mode
- When changed the time zone City, the time and date will change automatically to match
- It will return to referee mode automatically after 1 minute if there's no key pressed

The referee mode operate

- When in normal time mode, press B key to enter the referee mode
- Press D key to start countdown, meanwhile count up will automatically start
- Press D key to stop countdown when it's running, the additional time will automatically start counting
- Press D key to stop additional time and resume the countdown counting
- When countdown reached to 00 then automatic the period break time starts counting down to 00 The count up continue counting until you press D key to start next period.
- period break time count to 00. The count up continue run.
- Press D key to start the next period no matter period break time count to 00 or not, see below image:

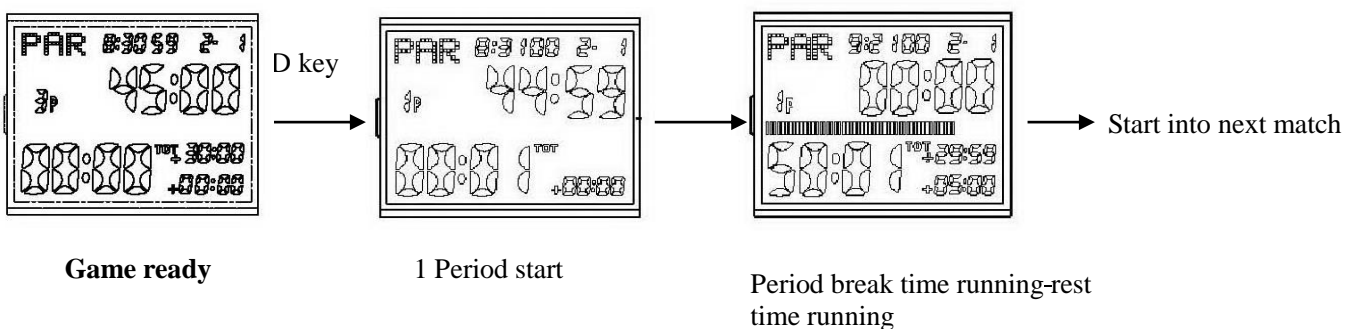

- When the watch is stopped during the game, the BB BB BB BB BB alarm will alert every 10 seconds, every time last 5 seconds (Only alert for the first 10 minutes)
- The indicator bar will running according to the every period of countdown and indicate the time of game. When the green and blue bar is completely filled the time of the game is finish.
- When countdown to 00, B.B.B.B...will alert every 0.5 second and will last about 10 seconds
- If you have set it to 3 periods, you see it on the display, but when you start the match it disappears and the display shows period 1
- When period break time count to 00, BB..BB...will alert for about 10 seconds
- The number of minutes for the haltime break will disappears when the match start

SPINTSO REFEREE WATCH2 X MANUAL



(Article number SPT140)

- When game running, press B key to switch to other mode. The referee mode will be running in the background
- When countdown in running or stopped, press D key for 5 seconds will delete the last period data and return to last period settings.
- When countdown in running or stopped, press C key to check the settings data, if press the C key more than 3 seconds will delete the current game time and return to the last settings.

Keytone:

- Every time you press D key to start, will alert B alarm, press D key to stop will alert BB alarm

3. Training mode (interval functions)

➤ Setting range:

- Training period: 1~99 P (period)
- Activity time (AT): 0~9 hour 59 minutes 59 seconds
- Activity resting (ART): 0~9 hour 59 minutes 59 seconds
- Resting time (RT): 0~59 minutes 59 seconds
- Total time (TOT): 0~99 hours 59 minutes 59.99 second

➤ Training mode (interval) setting:

When in interval training mode, press A key 3 seconds to enter setting, press B key will flash as below sequence:

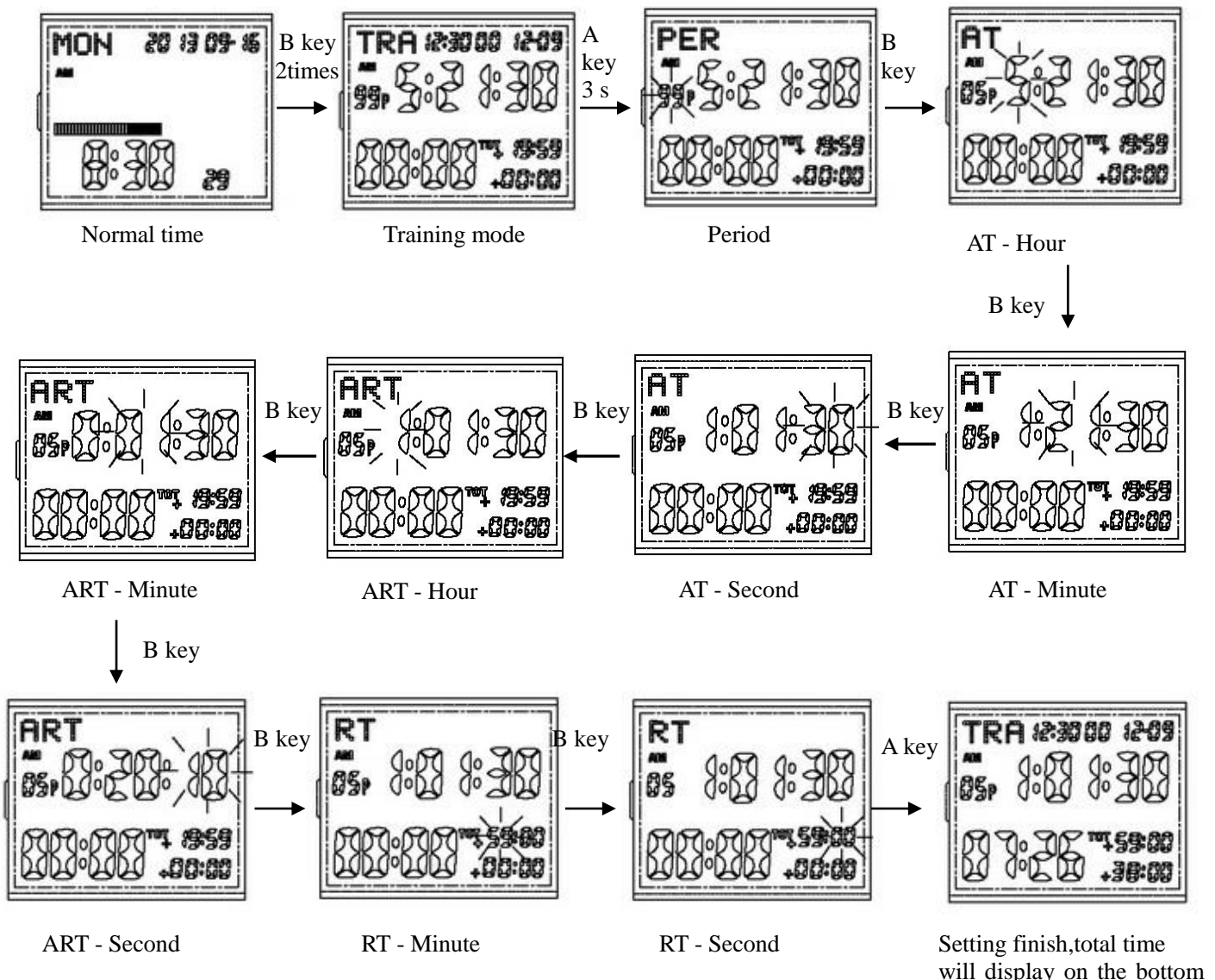

- Press D key to adjust increase, press C key will adjust decrease, keep pressing will adjust quickly
- In last step, press A key to confirm and exit setting, return to interval training mode (Even if during the setting press A key can exit setting)
- It will return to interval training mode automatically after 1 minute if there's no key pressed

SPINTSO REFEREE WATCH2 X MANUAL



(Article number SPT140)

➤ Training mode operate

- in normal time mode, Press B key to select Interval training mode
- Press D key to start count down, meanwhile will count up automatically total time
- When running, press D key to stop counting (no matter in activity time, activity rest or resting time)
- Press D key again to continue counting (activity time, activity rest or resting time)

Example training mode (interval) operate below as setting:

AT: 1:01:30
ART: 0:20:10
RT: 59minutes
Period: 5P

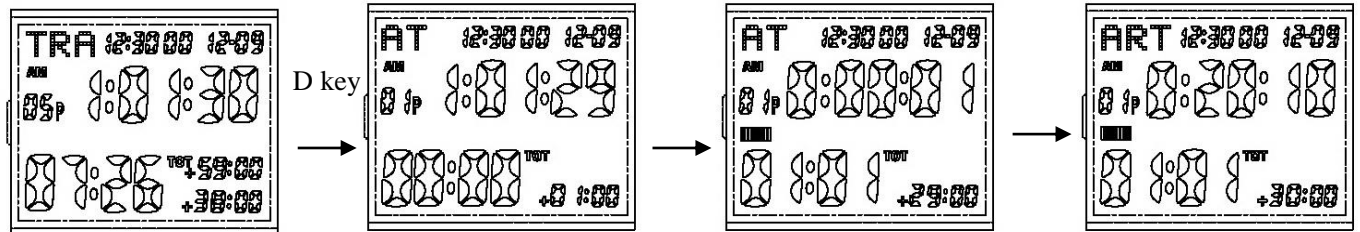

Original setting
display on the bottom
of the screen

1P AT Start

1P AT Almost to the end "0"

1P ART reach

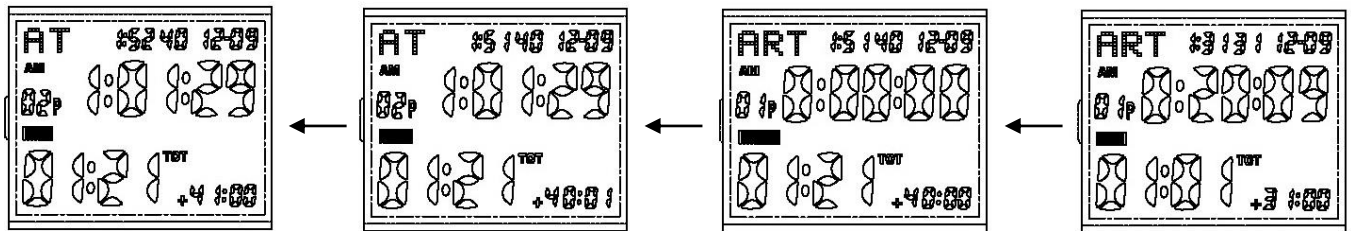

2P AT running

2P AT start

1P ART to "0"

1P ART running

Continue for 2-4 P

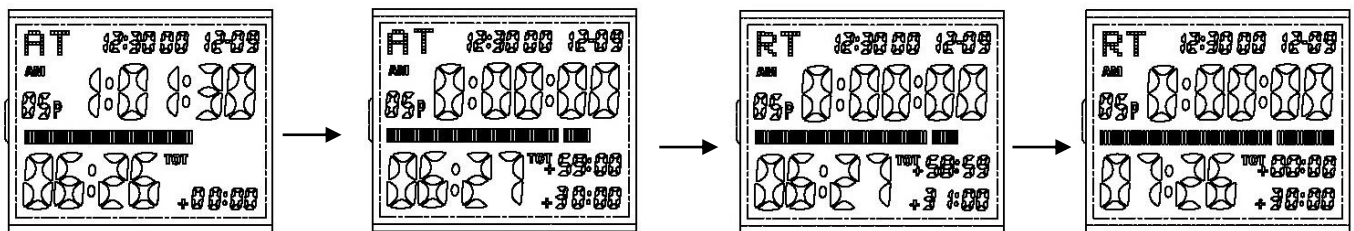

5P AT start

5P AT to "0"

RT start

RT to "00" and the whole
training finish, will display on
the bottom of the screen

- During the training (include AT, ART and RT), press D key can stop or continue count down.
- The whole indicator bar will consider filling according to the total time, TOT (include AT, ART, RT)
- When RT count to 00 will stop the training, the TOT will display in the bottom line as hour, minute, second, 1/100 second. TOT will include AT, ART, RT but not include the manual stop time
- Press C key 2 second erase the current counting and return to original stat.

SPINTSO REFEREE WATCH2 X MANUAL



(Article number SPT140)

Alarm sound description:

- 1) When start counting or resume counting after stop, 1 time B alarm for alert
- 2) When stop, will have one time BB alarm (alarm will alert every 10 seconds for reminder)
- 3) Every AT finish, 4 times(BB..BB..BB..BB) alarm as for alert.
- 4) Every ART finish, 4 times (BB..BB..BB..BB) alarm for alert
- 5) When it is time for RT (means finished the last period of activity time) alarm for alert. BB..BB.....will alert for about 10 seconds
- 6) When finish resting time, 4 times (.BB..BB..BB..BB)alarm for alert

2. Stop watch mode

- Stop watch range 0~99 hour 59 minute 59.99 second, it will stop when reach the max
- 99 LAP memory
- When using stop watch mode, press D key to start/stop, when stopped press C key for 3 seconds to clear to 00, before clear the data will flash within the 3 seconds

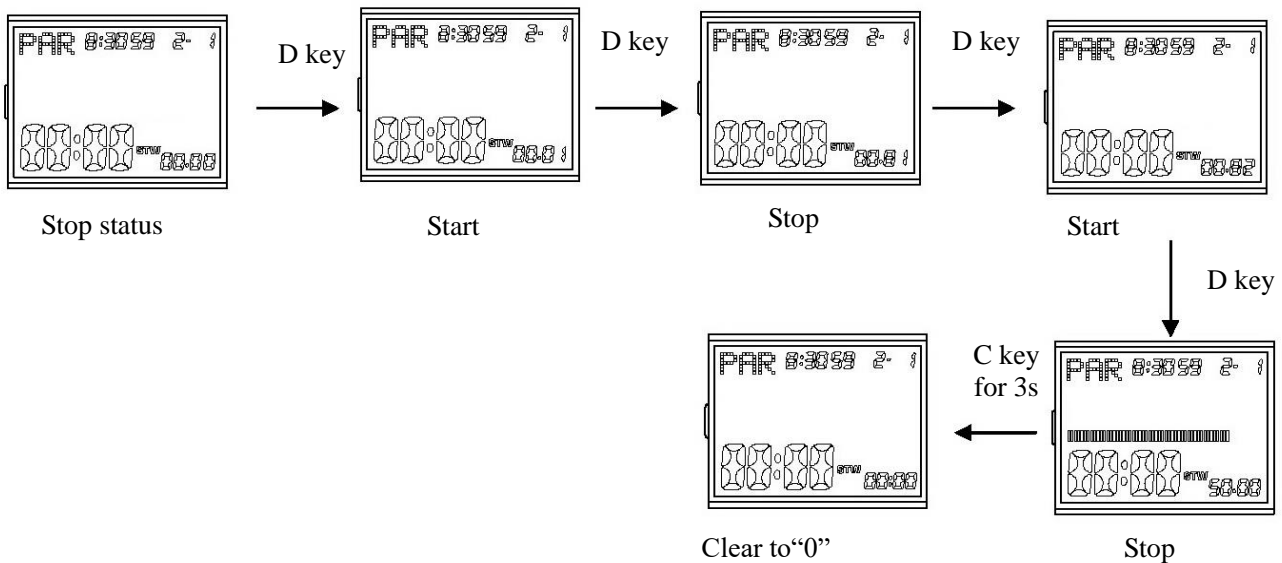

➤ LAP time operation:

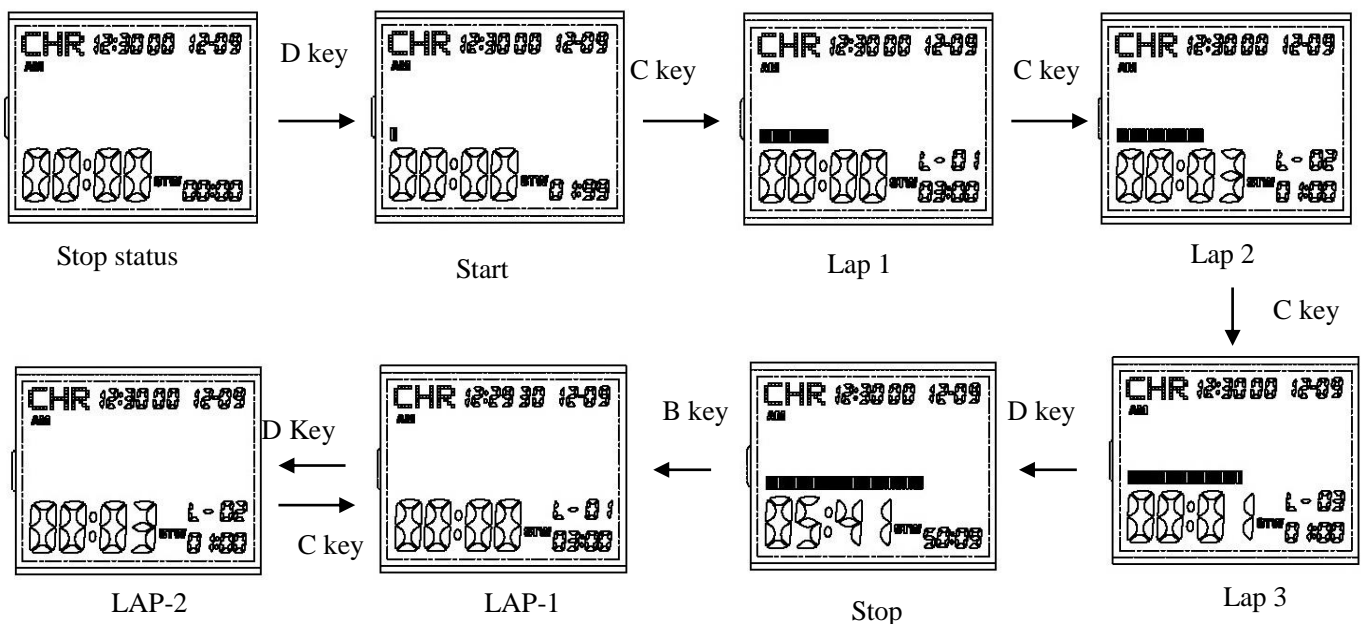

- In Stopwatch Mode, press D to start, press C to enter LAP time, to display the timing state after displaying the

SPINTSO REFEREE WATCH2 X MANUAL



(Article number SPT140)

- last group of LAP time for 5 seconds, then press D to stop and automatically record into the last group of LAP.
- When stopped, press B to enter the memory data to view the LAP time and TOT (total time) press D to view the data upward, press C to view the data downward. In viewed and stopped state, hold down C for 3 seconds to clear all LAP records, the data will flash in 3 seconds when is going to clear.
 - The stopwatch will continue counting if you don't stop it, and it will stop at 99 hours, 59 minutes, 59.99 seconds when up to its measuring limited. Stopwatch will not restart to measure from 0.
 - When stopwatch is running, press B for one second to return to normal time, the stopwatch will run at the background.
 - When 99 groups of LAP time is recorded fully, new LAP time will not able to be recorded, the indicator of "FULL" will flash on the screen.

5. Alarm mode

In alarm mode, press D key to ON/OFF the alarm, press A key for 3 seconds the HOUR will flash, press B key to select MINUTE or HOUR, it will flash as below:

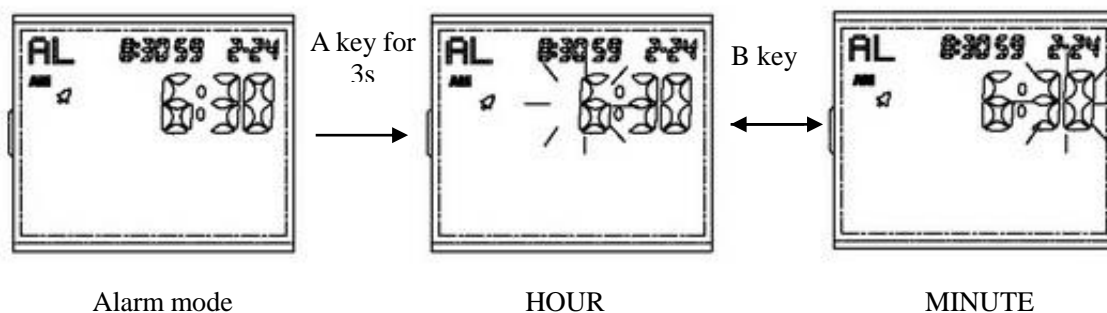

- Press D key to adjust increase, press C key will adjust decrease, keep pressing will adjust quickly
- Press A key to confirm and return to Alarm mode
- It will return to alarm mode automatically after 1 minute if there's no key pressed
- If alarm ON, and time reach the time setting, BB..BB.. alarm will alert 20 seconds, the icon “🔔” will flash, press any key to stop alarm.

C. Standard

- Case dimension : 42x35x15mm
- Weight : 58g
- Work temperature : -10°C~60°C
- Work voltage : 3V
- Time Veracity : ± 30 seconds/month
- Battery type : CR2032
- Static average drive current : ≤8.54 u A
- Alarm ring current : ≤12 m A
- Lighting current average : ≤7.36 m A
- Battery life term : ≥ 1year
- 10ATM
- Sound 75db

SPINTSO REFEREE WATCH2 X MANUAL



(Article number SPT140)

The battery life: Since the battery in your watch is battery monitor inserted at the factory to check the function and performance of the watch, it may run down in less than the specified period after that date of purchase

When you replace the batteries: Do not install the new 2-3 minutes, have you changed them without waiting it may happen that the battery icon appears on the display, then you needed to take them out and wait for 2-3 minutes to all power discharged from the circuit board and the Watch is reset

10 ATM: Never operate the button in water, otherwise water may gate inside the watch and damage it

City Code	City	GMT Differential	Other major cities in same time zone
ATH	Athens	+02.0	Helsinki, Beirut, Damascus, Cape Town
JNB	Johannesburg		
IST	Istanbul		
CAI	Cairo		
JRS	Jerusalem		
MOW	Moscow	+03.0	Kuwait, Riyadh, Aden, Addis Ababa, Nairobi
JED	Jeddah	+03.5	Shiraz
THR	Tehran		
DXB	Dubai	+04.0	Abu Dhabi, Muscat
KBL	Kabul	+04.5	
KHI	Karachi	+05.0	
MLE	Male		
DEL	Delhi	+05.5	Mumbai, Kolkata
DAC	Dhaka	+06.0	Colombo
RGN	Yangon	+06.5	
BKK	Bangkok	+07.0	Phnom Penh, Hanoi, Vientiane
JKT*	Jakarta		
SIN*	Singapore	+08.0	Kuala Lumpur, Taipei, Manila, Perth, Ulaanbaatar
HKG	Hong Kong		
BJS	Beijing		
SEL	Seoul	+09.0	Pyongyang
TYO	Tokyo		
ADL	Adelaide	+09.5	Darwin
GUM	Guam	+10.0	Melbourne, Rabaul
SYD	Sydney		
NOU	Noumea	+11.0	Port Vila
WLG	Wellington	+12.0	Christchurch, Nadi, Nauru Island
TBU	Nuku'Alofa	+13.0	

SPINTSO REFEREE WATCH2 X MANUAL



(Article number SPT140)

GMT Differential/City Code List

City Code	City	GMT Differential	Other major cities in same time zone
PPG	Pago Pago	-11.0	
HNL	Honolulu	-10.0	Papeete
ANC	Anchorage	-09.0	Nome
YVR	Vancouver	-08.0	Las Vegas, Seattle / Tacoma, Dawson City
SFO	San Francisco		
LAX	Los Angeles		
DEN	Denver	-07.0	Edmonton, El Paso
MEX	Mexico City	-06.0	Houston, Dallas/Fort Worth, New Orleans, Winnipeg
CHI	Chicago		
MIA	Miami	-05.0	Montreal, Detroit, Boston, Panama City, Havana, Lima, Bogota
NYC	New York		
CCS	Caracas	-04.0	La Paz, Santiago, Port Of Spain
YYT	St. Johns	-03.5	
RIO	Rio De Janeiro	-03.0	Sao Paulo, Buenos Aires, Brasilia, Montevideo
RAI	Praia	-01.0	
LIS	Lisbon	+00.0	Dublin, Casablanca, Dakar, Abidjan
LON	London		
BCN	Barcelona	+01.0	Amsterdam, Algiers, Hamburg, Frankfurt, Vienna, Madrid, Stockholm
PAR	Paris		
MIL	Milan		
ROM	Rome		
BER	Berlin		